

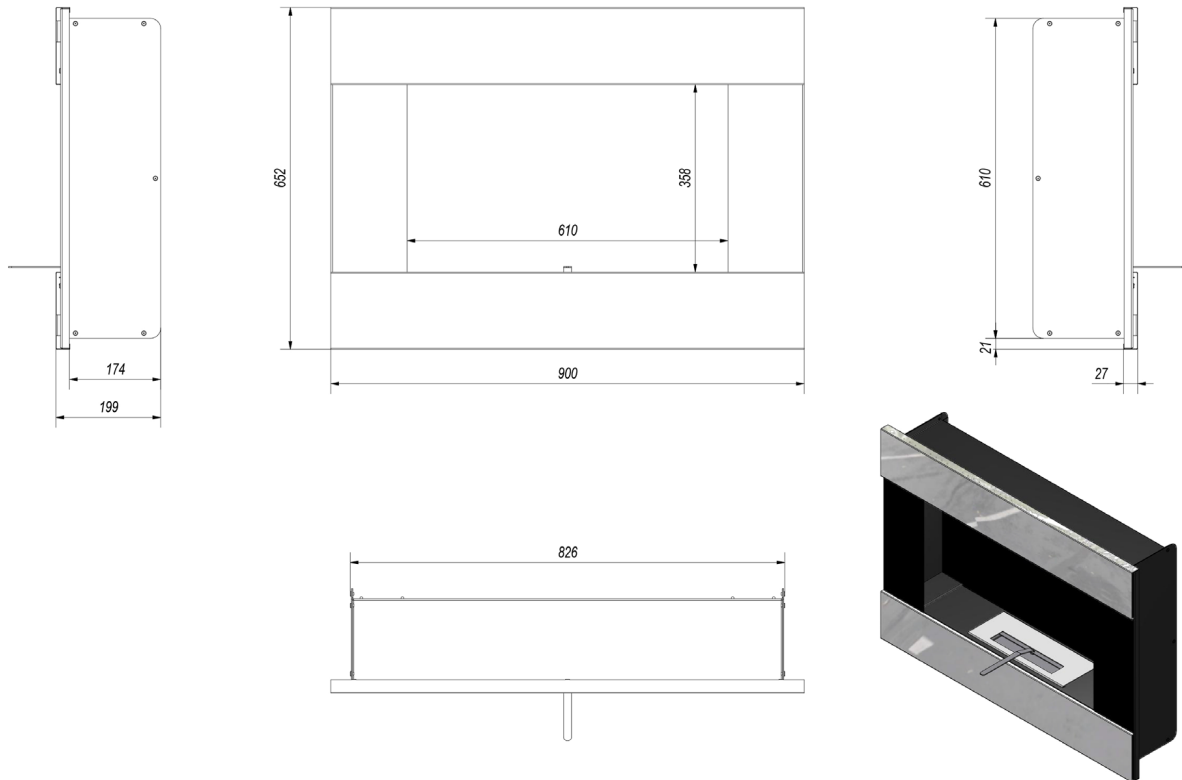

BIO-80-044



TECHNICAL SPECIFICATIONS

Type	Wall-mounted bioethanol fireplace
Size	Height: 652 mm / Width: 900 mm / Depth: 174 mm
Materials	Steel
Weight	Approx. 23 kg.
Burner	Adjustable Manuel burner (Burner width: 300 mm / Flame width: 250 mm)
Capacity	0,5 Liter
Usage	Approx 0.25 L/h - Up to 3 hours per filling
Fuel	Bioethanol (Recommended 96,6% alcohol)
Colour	Several colors
Heat Output	1,2 kW
Electricity	No